

Turmdrehkran

Tower Crane / Grue à tour / Gru a torre
Grúa torre / Guindaste de torre

224 EC-H 12 FR.tronic®

224 EC-H 12 Litronic®

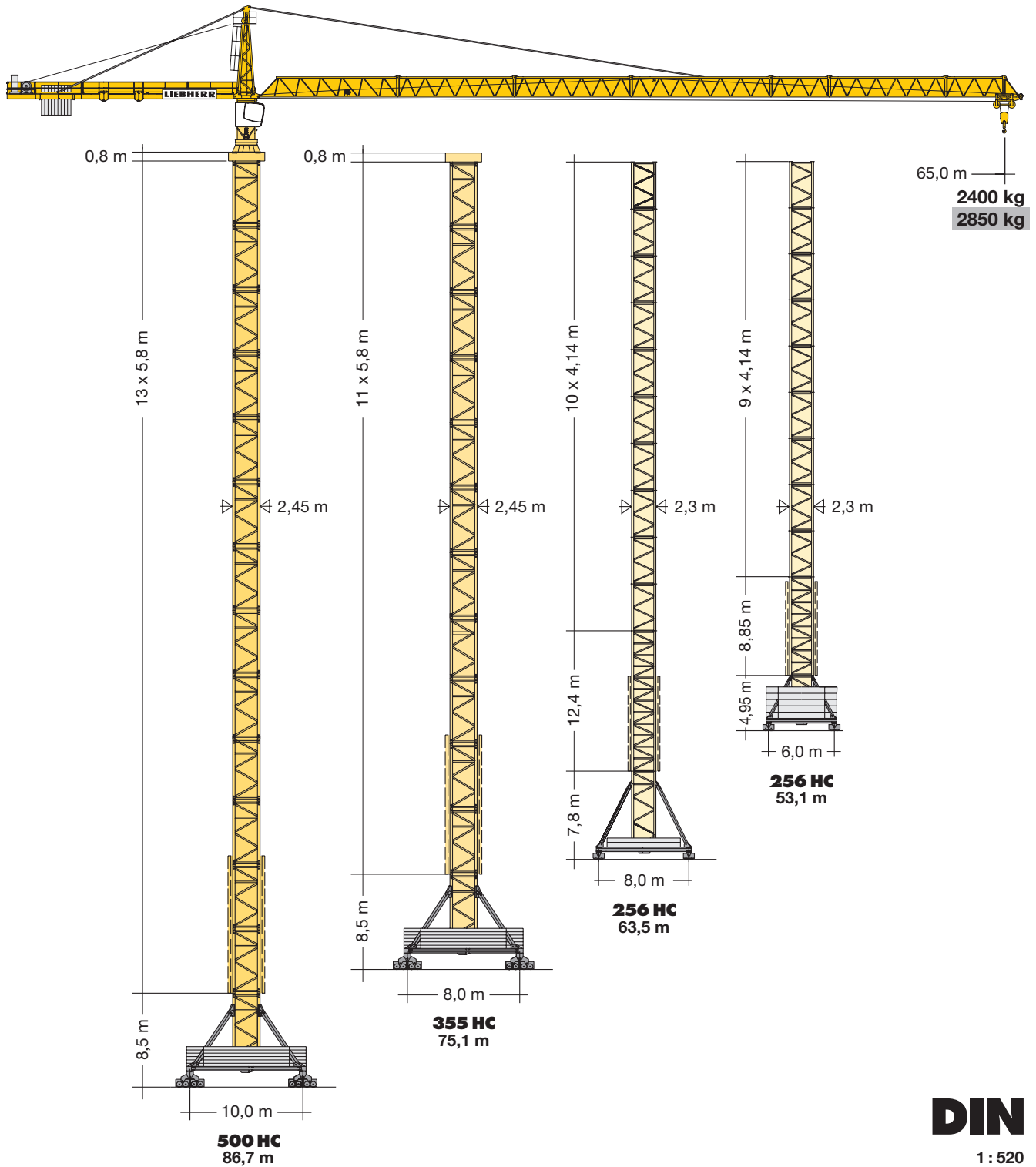

LIEBHERR

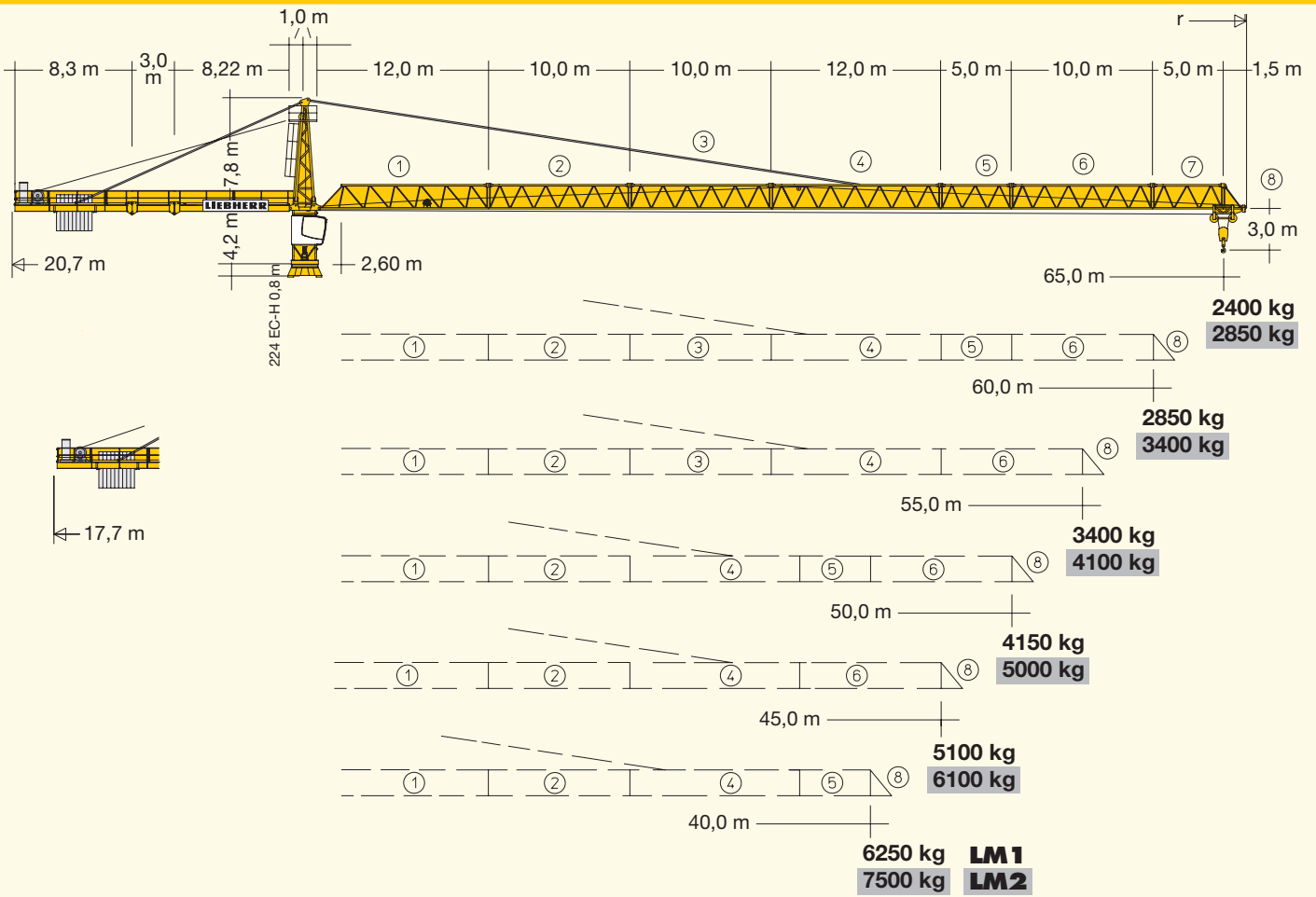

Hubhöhe

Hoisting height / Hauteur sous crochet / Altezza di sollevamento / Altura bajo gancho / Altura de montagem

	256 HC					355 HC			500 HC	
13	-	-	-	-	-	-	-	-	78,5*	86,7*
12	-	-	-	-	-	-	-	-	72,7	80,9
11	-	-	-	-	-	66,9*	75,1*	-	66,9	75,1
10	-	56,0*	-	-	63,5*	61,1	69,3	-	61,1	69,3
9	48,4*	51,9	53,1*	56,6*	59,4	55,3	63,5	-	55,3	63,5
8	44,3	47,7	49,0	52,5	55,3	49,5	57,7	-	49,5	57,7
7	40,1	43,6	44,8	48,4	51,1	43,7	51,9	-	43,7	51,9
6	36,0	39,4	40,7	44,2	47,0	37,9	46,1	-	37,9	46,1
5	31,8	35,3	36,5	40,1	42,8	32,1	40,3	-	32,1	40,3
4	27,7	31,2	32,4	35,9	38,7	26,3	34,5	-	26,3	34,5
3	23,6	27,0	28,3	31,8	34,6	20,5	28,7	-	20,5	28,7
2	19,4	22,9	24,1	27,7	30,4	14,7	22,9	-	14,7	22,9
1	15,3	18,7	20,0	23,5	26,3	8,9	17,1	-	8,9	17,1
0	a) 11,1 b) 14,6	a) 15,8 b) 19,4		22,1	3,1	11,3	-	3,1	11,3	
	m					m			m	

* Weitere Hubhöhen, Auslegerlängen sowie Klettern im Gebäude auf Anfrage. / Further hoist heights and jib lengths as well as climbing inside the building on request. / Autres hauteurs sous crochet et longueurs de flèche ainsi que hissage dans le bâtiment sur demande. / Ulteriori altezze gancho, lunghezze braccio così come telescopaggio all'interno dell'edificio: su richiesta. / Para alturas bajo gancho superiores, otros alcances y trepado en el interior del edificio, consultar. / Outras alturas de elevação, comprimentos de lança e subida no edifício: sob consulta.

Ausladung und Tragfähigkeit

Radius and capacity / Portée et charge / Sbraccio e portata / Alcances y cargas / Alcance e capacidade de carga

		224 EC-H 12 FR.tronic®													
m	r	m/kg	m/kg												
			19,0	22,0	25,0	28,0	31,0	34,0	37,0	40,0	45,0	50,0	55,0	60,0	65,0
65,0	(r=66,6)	2,6-17,8 12000	11150	9450	8160	7150	6340	5670	5110	4640	3990	3470	3050	2700	2400
60,0	(r=61,6)	2,6-18,5 12000	11640	9870	8530	7480	6630	5940	5360	4870	4190	3660	3220	2850	
55,0	(r=56,6)	2,6-19,3 12000	12000	10330	8940	7840	6960	6240	5630	5120	4420	3860	3400		
50,0	(r=51,6)	2,6-20,4 12000	12000	11010	9530	8370	7440	6670	6030	5490	4740	4150			
45,0	(r=46,6)	2,6-21,6 12000	12000	11740	10170	8940	7960	7140	6460	5890	5100				
40,0	(r=41,6)	2,6-22,7 12000	12000	12000	10760	9460	8420	7570	6860	6250					

LM 1

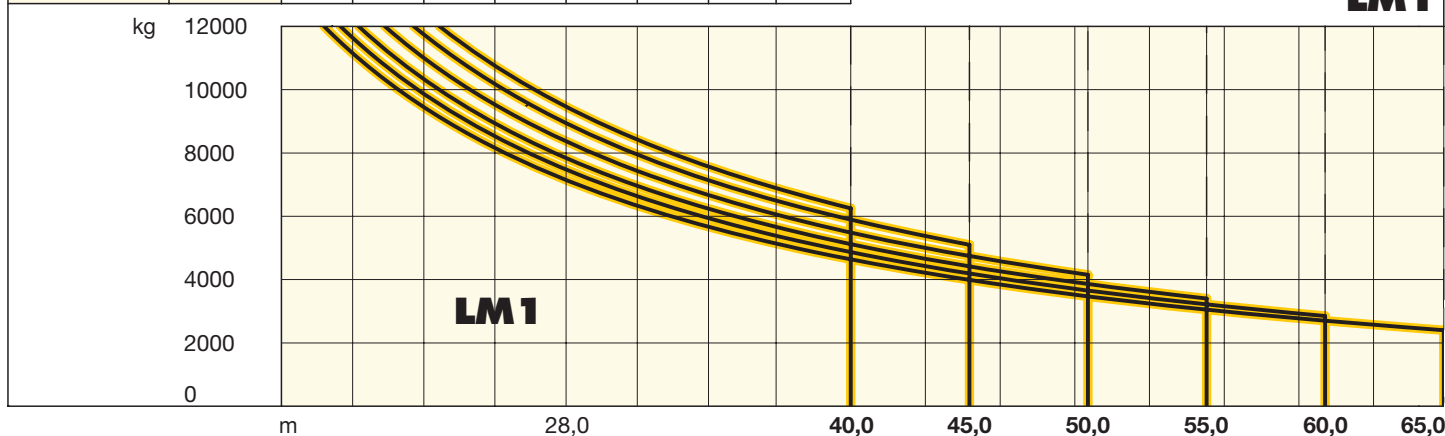

Antriebe FR.tronic®/Litronic®

Driving units / Mécanismes d'entraînement / Azionamenti / Mecanismos / Mecanismos

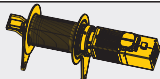

45 kW FU
WIW 260 MZ 402

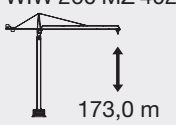

173,0 m

max. 256,0 m**

↔ **stufenlos** / stepless / régl. continu
regl. progressiva / sin escalones / sem degraus
kg m/min

5 Lagen
Layers
Couches
Strati
Camadas
Capas

1	12000	0 ↔ 19
	1150	0 ↔ 94

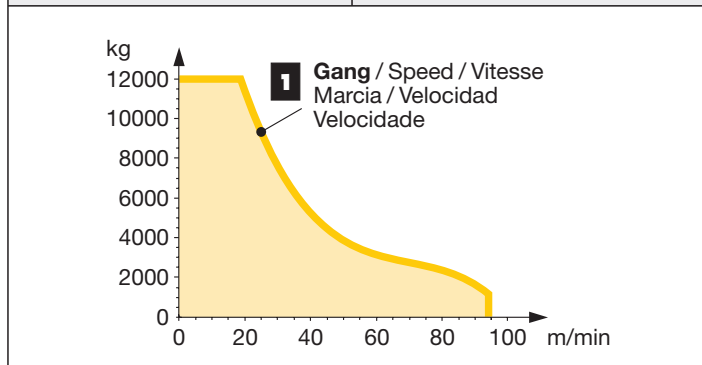

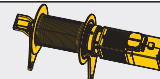

65 kW FU
WIW 280 MZ 401

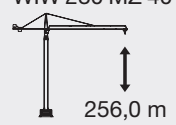

256,0 m

↔ **stufenlos** / stepless / régl. continu
regl. progressiva / sin escalones / sem degraus
kg m/min

7 Lagen
Layers
Couches
Strati
Camadas
Capas

1	12000	0 ↔ 27
	2300	0 ↔ 96

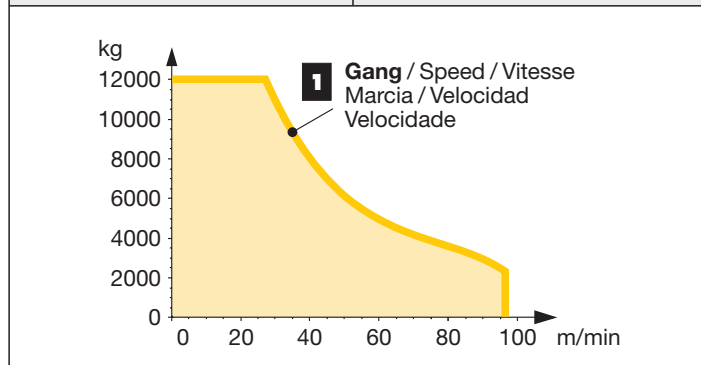

** Weitere Hublastdaten: siehe Betriebsanleitung. / Further hoist data: see instruction manual. / Autres données de la charge de levage: voir manuel d'instruction. / Altri dati sui carichi sollevati: consultare il manuale d'istruzione. / Alturas bajo grancho superiores según manual. / Outras tabelas de carga: consultar manual de instruções.

m	r	224 EC-H 12 Litronic®													
		m/kg													
		19,0	22,0	25,0	28,0	31,0	34,0	37,0	40,0	45,0	50,0	55,0	60,0	65,0	
65,0	(r=66,6)	2,6-17,8 12000	11150	9450	8500	8200	7280	6530	5900	5370	4640	4060	3580	3190	2850
60,0	(r=61,6)	2,6-21,0 12000	12000	11390	9860	8660	7700	6910	6250	5690	4930	4320	3820	3400	
55,0	(r=56,6)	2,6-22,2 12000	12000	12000	10490	9230	8210	7380	6680	6090	5280	4630	4100		
50,0	(r=51,6)	2,6-23,6 12000	12000	12000	11240	9890	8810	7920	7180	6550	5690	5000			
45,0	(r=46,6)	2,6-25,0 12000	12000	12000	11980	10560	9410	8470	7680	7010	6100				
40,0	(r=41,6)	2,6-22,7 12000	12000	12000	10760	9500	9500	9040	8210	7500					

LM1 + LM2

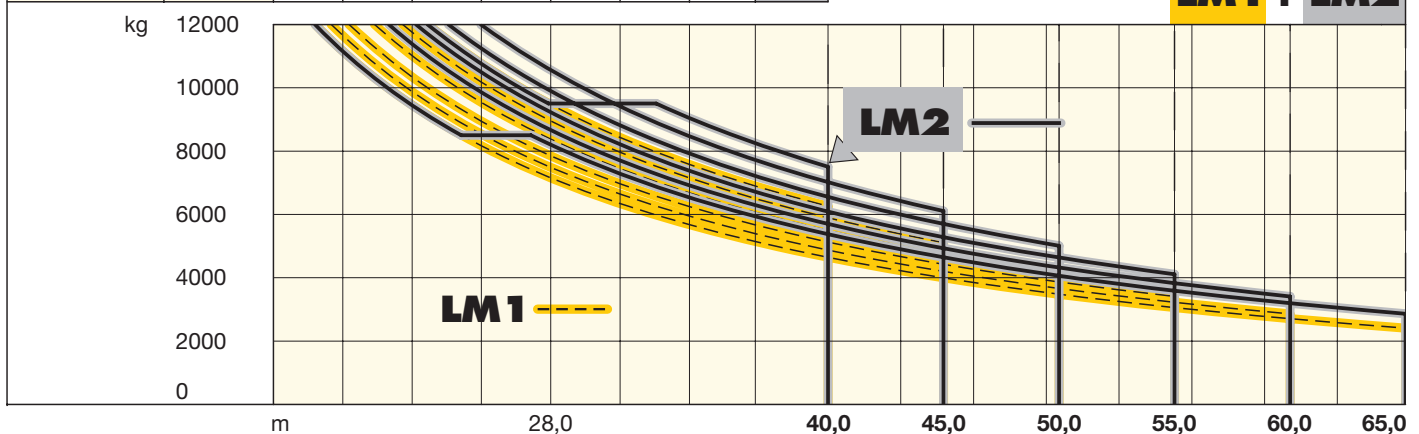

Antriebe FR.tronic®/Litronic®

Driving units / Mécanismes d'entraînement / Azionamenti / Mecanismos / Mecanismos



65 kW FU
WIW 280 VZ 401

7 **Lagen**
Layers
Couches
Strati
Camadas
Capas

256,0 m

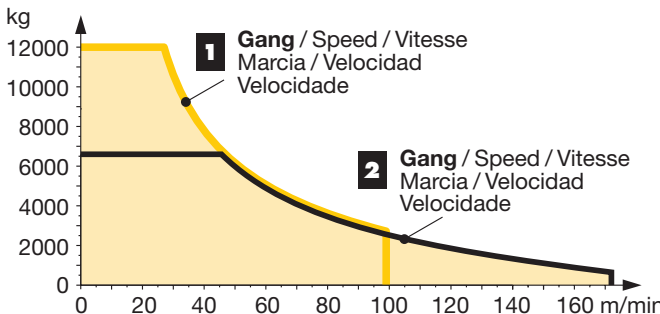

↔ **stufenlos** / stepless / régl. continu
regl. progressiva / sin escalones / sem degraus
kg m/min

1	12000	0 ↔ 27
	2300	0 ↔ 99
2	6600	0 ↔ 48
	650	0 ↔ 172





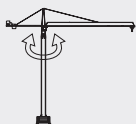
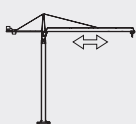

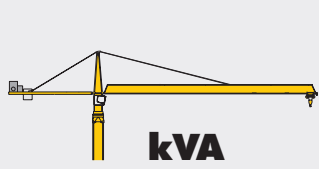







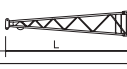



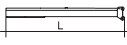

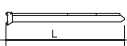





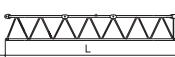







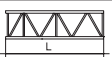







1 Gang / Speed / Vitesse
Marcia / Velocidad
Velocidade

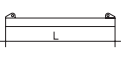

2 Gang / Speed / Vitesse
Marcia / Velocidad
Velocidade

	0 ↔ 0,7 U/min sl./min tr./min	2 x 7,5 kW FU						
	0 ↔ 1 10,0 m/min	7,5 kW FU						
	25,0 m/min	4 x 7,5 kW (500 HC, 355 HC) 2 x 7,5 kW (256 HC)						
 kVA		<table border="1" style="width: 100%;"> <tr> <td>45 kW FU</td> <td>65 kW FU</td> <td>65 kW FU</td> </tr> <tr> <td>63,0</td> <td>86,0</td> <td>86,0</td> </tr> </table>	45 kW FU	65 kW FU	65 kW FU	63,0	86,0	86,0
45 kW FU	65 kW FU	65 kW FU						
63,0	86,0	86,0						

LM 2 Abweichende Geschwindigkeiten und Betriebsbedingungen.
Variant speeds and service conditions. / Vitesses et conditions de fonctionnement différentes. / Differenti velocità e condizioni di funzionamento. / Otras velocidades y características de funcionamiento. / Outras velocidades e características de funcionamento.

Litronic: kVA reduzierbar bei zu geringer Netz-Anschlussleistung, siehe BAL. / kVA can be reduced in case of too little power of the mains, see instruction manual. / kVA peut être réduit en cas de trop faible puissance du réseau, voir manuel d'instruction. / kVA riducibili in caso di potenza di rete ridotta (si veda manuale uso e manutenzione) / kVA variable para potencia de red demasiado pequeña, ver Manual de instrucciones. / kVA reduzível no caso de capacidade da rede elétrica muito baixa, ver manual de instruções.

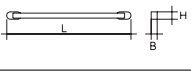
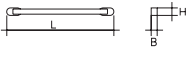
Kranoberteil		Upper part of crane / Partie supérieure de grue / Parte superiore della gru	Parte superior grúa / Parte superior do guindaste	L (m)	B (m)	H (m)	kg*		
Pos. Item Rep. Voce Pos. Ref.	Anz. Qty. Qte. Qta. Cant. Cant.	Drehbühne / Slewing platform / Ensemble mât-cabine / Piattaforma girevole / Conjunto plataforma de giro / Plataforma giratória			5,40	2,74	2,64	10120	
1	1								
2	1	Turmspitze / Tower head Porte-flèche / Cuspide / Cabeza de torre Cabeça de apoio de lança			7,90	1,62	1,80	2500	
3	1	Hubwerkseinheit / Hoist gear unit / Treuil de levage Gruppo meccanismo sollevamento / Mecanismo de elevación / Grupo de mecanismo elevatório			2,20	2,39	1,74	3300	
4	1	Gegenausleger-Kopfstück / Counter-jib head Pointe de contre-flèche / Testa di controbraccio Tramo punta de contrapluma / Cabeça de contra-lança			8,50	2,42	0,92	2850	
5	1	Gegenausleger-Anlenkstück / Counter-jib heel section Pied de contre-flèche / Settore articolato di controbraccio / Tramo primero-contrapluma Base articulada da contra-lança			8,44	1,77	0,92	2800	
6	1	Gegenausleger-Zwischenstück / Intermediate counter-jib section / Élément interm. de contre-flèche Spezzone di controbraccio / Tramo intermedio de contrapluma / Peça suplementar da contra-lança			3,22	1,76	0,92	950	
7	1	Ausleger-Anlenkstück / Jib heel section Pied de flèche / Settore articolato di braccio Pluma tramo primero / Base articulada de lança			12,26	1,86	1,96	① 2980	
8	1	Ausleger-Zwischenstück / Intermediate jib section Élément intermédiaire de flèche / Spezzone di braccio Tramo intermedio pluma / Peça suplementar da lança			10,40	1,63	1,85	② 1680	
1	10,40				1,63	1,85	③ 1610		
1	12,30				1,63	1,85	④ 1840		
1	5,30				1,63	1,85	⑤ 585		
1	10,40				1,63	1,85	⑥ 1100		
1	5,30				1,63	1,85	⑦ 400		
9	1	Ausleger-Kopfstück / Jib head section Pointe de flèche / Punta freccia Tramo punta de pluma / Cabeça de lança			1,70	1,84	2,05	⑧ 300	
10	1	Laufkatze und Lasthaken / Trolley and hook Chariot de distribution et crochet / Carrello con gancio Carrito y gancho / Carro de ponte e gancho			1,89	1,83	1,20	1150	
Turm		Tower / Mât / Torre Torre / Torre							
11	9	Turmstück / Tower section Élément de mât / Elemento di torre Tramo torre / Torre			256 HC	4,14	2,30	2,30	2300
11	355 HC				6,28	2,45	2,45	5050	
13	500 HC				6,28	2,45	2,45	6480	
12	1	Turmstück lang / Long tower section Élément de mât long / Elemento di torre, lungo Tramo de torre largo / Peça de torre, comprida			256 HC	12,42	2,30	2,30	5770
13	1	Grundturmstück / Base tower section Mât de base / Elemento di torre base Tramo base / Peça de base de torre			256 HC	8,85 (12,42)	2,30 (2,30)	2,30 (2,30)	4830 (7940)
Klettereinrichtung		Climbing equipment / Equipement de télescopage / Attrezzatura per allungamento della gru Equipo de trepado / Acesórios p. subida no edificio							
14	1	Führungstück kpl., geteilt / Guide section cpl., split Cage télescopique cpl., dévisée / Gabbia de sopraelevazione compl., suddivisa Torre de montaje, dividida / Peça de guia, subdividida			256 HC	8,39	2,68	2,58 (3,04)	5100
	355 HC				12,39	2,75	1,58	8300	
	500 HC				12,39	2,75	1,58	8300	
15	1	Hydraulikanlage, Stütz- und Klettertraverse / Hydraulic unit, supporting and climbing cross members / Système hydraulique avec traverses d'appui et de télescopage / Sistema idraulico, traversa di appoggio e allungamento gru Sistema hidráulico con traviesa de apoyo y trepado / Instalação hidráulica, travessa de apoio e subida			256 HC	2,10	1,25	1,00	1150
	355 HC				2,10	1,10	1,00	1810	
	500 HC				2,10	1,10	1,00	1810	
Unterwagen		Undercarriage / Châssis / Carro della gru Carro con mástil / Carro de guindaste							
16	4	Ausgleichsschwinge mit Schwingenlager / Pivot for wheel box / Chape pour bogie / Bilanciere di equilibratura con cuscinetto bilanciere / Balancim Balancim com suporte			355 HC	1,60	0,72	1,48	1390
	500 HC								
17	2	Fahrschemel mit Antrieb / Rail bogie with drive Bogie moteur / Telaio con gruppo propulsore Caja rodillo motriz / Quadro sem grupo de propulsão			256 HC	1,63 (1,46)	0,92 (0,84)	0,95 (0,87)	1690 (920)
4	355 HC				1,40	0,75	0,65	920	
4	500 HC				1,45	0,82	0,72	1690	
18	2	Fahrschemel ohne Antrieb / Rail bogie without drive / Bogie fou / Telaio senza gruppo propulsore / Caja rodillo conducido / Quadro com grupo de propulsão			256 HC	1,37 (1,15)	0,62 (0,60)	0,95 (0,87)	1340 (880)
4	355 HC				1,10	0,60	0,65	880	
4	500 HC				1,30	0,40	0,72	1340	
19	1	Tragholm lang / Long support arm Longeron long / Longherone lungo Braço soporte largo / Travessa comprida			256 HC	9,10 (11,95)	0,80 (0,82)	0,80 (0,80)	1650 (2200)
1	355 HC				11,82	0,92	0,93	3515	
2	500 HC				7,32	0,92	0,93	2330	
20	2	Tragholm kurz / Short support arm Longeron court / Longherone corto Braço soporte corto / Travessa curta			256 HC	4,45 (5,58)	0,77 (0,65)	0,77 (0,77)	800 (1035)
	355 HC				5,74	0,80	0,90	1600	
	500 HC				7,14	0,80	0,90	2135	

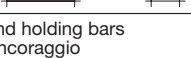
Pos. Item Rep. Voce Pos. Ref.	Anz. Qty. Qte. Qta. Cant. Cant.				L (m)	B (m)	H (m)	kg*
21	2 + 2	Randträger / Border support Traverse / Supporti base Traviesa / Apoio de bordo		256 HC	5,46 – 5,40	0,11 – 0,18	0,16 – 0,38	175 – 525
				355 HC	(7,52 – 7,46)	(0,1 – 0,17)	(0,1 – 0,38)	(366 – 912)
				500 HC	7,30	0,14	0,14	340
					9,30	0,14	0,14	510
22	4	Stützholm / Support strut Hauban de châssis / Correnti di appoggio Tirante vertical / Travessa de apoio		256 HC	4,14 (6,55)	0,18 (0,22)	0,25 (0,25)	320 (600)
				355 HC	6,06	0,26	0,34	862
				500 HC	6,98	0,26	0,34	1140
23	1	Unterswagen-Turmstück / Undercarriage tower section / Mât de châssis / Elemento di torre del carro / Tramo de carro / Peça de torre do chassis		256 HC	3,73 (6,70)	2,62 (2,53)	2,62 (2,53)	2550 (3800)
				355 HC	6,61	2,44	2,44	7475
				500 HC	6,61	2,44	2,44	7930
24		Kleinteile, Seile und Abspannungen / Small parts, ropes and holding bars Accessoires, câbles et tirants / Accessori, funi e attrezzi di ancoraggio Despieces, cables y tirantes / Acessórios, cabos e peças de ancoragem		256 HC				
				355 HC	9,00	1,60	1,00	5000
				500 HC				

() **Angaben in Klammern gelten für 8 m-Unterswagen.** / The data in brackets are valid for an undercarriage of 8 m. / Les données techniques indiquées entre parenthèses sont valables pour un châssis de 8 m. / Caratteristiche in (...) valgono per carro di 8 m. / Los datos entre paréntesis son válidos para carro de 8 m. Características em (...) válidas pelo chassis de 8 m.

* **Einzelgewichte.** / Single weights. / Poids individuels. / Pesì di componenti. / Pesos unitarios. / Pesos de peças componentes.

Konstruktionsänderungen vorbehalten!

Subject to alterations! / Sous réserves de modifications!
Si fa riserva di modifiche! / ¡Sujeto a modificaciones!
Salvo modificação da construçao!

Sämtliche Angaben erfolgen ohne Gewähr. / This information is supplied without liability.

Ces renseignements sont sans garantie. / Le indicazioni contenute si intendono salvo errori ed omissioni.
Declinamos toda responsabilidad derivada de la información proporcionada. / Declinamos qualquer
responsabilidade quanto à informação fornecida.